

Data sheet | Item number: 280-504/281-585

Component terminal block; double-deck; with end plate; with varistor; for DIN-rail 35 x 15 and 35 x 7.5; 2.5 mm<sup>2</sup>; CAGE CLAMP®

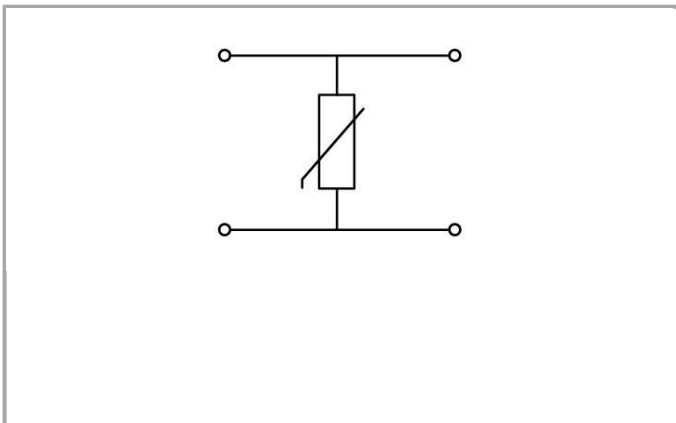

280-504/281-585

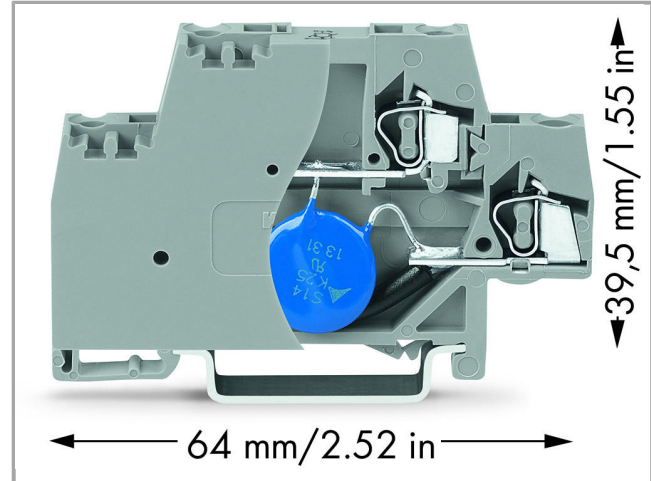
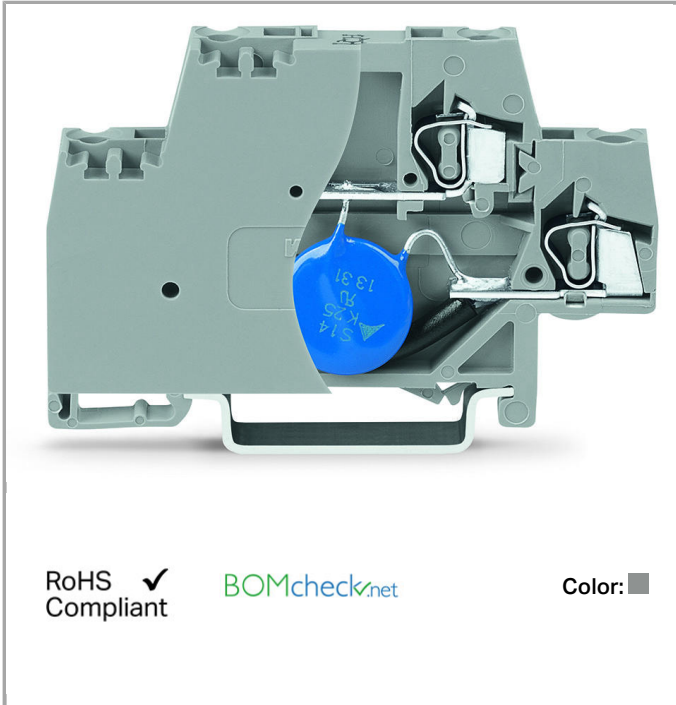

Item description

Short description:

Terminal blocks with surge suppression device and direct connection to the DIN-35 rail; these single-stage surge suppression devices are equipped either with 280 Series gas-filled surge arrester (coarse), varistor (medium) or suppressor diode (fine).

Features:

- Protect your system against overvoltage
- Slim, space-saving design

- Control operational costs by preventing expensive, unplanned downtime
- High operational reliability and system uptime

## Data

### Electrical data

Nominal operating voltage	DC 110 V
Maximum continuous operating voltage	DC 150 V
Rated continuous current	20 A
Nominal discharge current (8/20 $\mu$ s) per line	1 kA
Max. discharge current	4.5 kA
Voltage protection level (8/20 $\mu$ s)	$\leq$ DC 300 V
Response time line/line	$\leq$
Capacitance	$\leq$ 800 pF

### Connection data

Connections (number)	4
Connection technology	CAGE CLAMP®
Solid conductor	0.08 ... 2.5 mm <sup>2</sup> / 28 ... 14 AWG
Fine-stranded conductor	0.08 ... 2.5 mm <sup>2</sup> / 28 ... 14 AWG
Strip length	8 ... 9 mm / 0.31 ... 0.35 inch

### Geometrical Data

Width	10 mm / 0.394 inch
Height from upper-edge of DIN-35 rail	39.5 mm / 1.555 inch
Depth	64 mm / 2.52 inch

### Mechanical data

Design	With end plate
Type of mounting	DIN-35 rail

### Material Data

Color	gray
Fire load	0.265 MJ
Weight	15.145 g

### Commercial data













Product Group	1 (Rail Mounted Terminal Blocks)
Country of origin	DE
GTIN	4050821666059

Customs Tariff No.





8536901000

## Compatible products



## Marking accessories

	<b>Item no.: 2009-145</b> Mini-WSB Inline; for Smart Printer; on reel; stretchable 5 - 5.2 mm; plain; snap-on type		2009-145
	<b>Item no.: 2009-145/000-002</b> Mini-WSB Inline; for Smart Printer; on reel; stretchable 5 - 5.2 mm; plain; snap-on type	/000-002	2009-145
	<b>Item no.: 2009-145/000-005</b> Mini-WSB Inline; for Smart Printer; on reel; stretchable 5 - 5.2 mm; plain; snap-on type	/000-005	2009-145
	<b>Item no.: 2009-145/000-006</b> Mini-WSB Inline; for Smart Printer; on reel; stretchable 5 - 5.2 mm; plain; snap-on type	/000-006	2009-145
	<b>Item no.: 2009-145/000-007</b> Mini-WSB Inline; for Smart Printer; on reel; stretchable 5 - 5.2 mm; plain; snap-on type	/000-007	2009-145
	<b>Item no.: 2009-145/000-012</b> Mini-WSB Inline; for Smart Printer; on reel; stretchable 5 - 5.2 mm; plain; snap-on type	/000-012	2009-145
	<b>Item no.: 2009-145/000-023</b> Mini-WSB Inline; for smartPRINTER; on reel; stretchable 5 - 5.2 mm; plain; snap-on type	/000-023	2009-145
	<b>Item no.: 2009-145/000-024</b> Mini-WSB Inline; for Smart Printer; on reel; stretchable 5 - 5.2 mm; plain; snap-on type	/000-024	2009-145
	<b>Item no.: 248-501</b> Miniature WSB Quick marking system; plain; Marker width 5 mm; 10 strips with 10 markers per card		248-501
	<b>Item no.: 248-501/000-002</b> Mini-WSB marking card; as card; not stretchable; plain; snap-on type	/000-002	248-501
	<b>Item no.: 248-501/000-005</b> Mini-WSB marking card; as card; not stretchable; plain; snap-on type	/000-005	248-501
	<b>Item no.: 248-501/000-006</b> Mini-WSB marking card; as card; not stretchable; plain; snap-on type	/000-006	248-501
	<b>Item no.: 248-501/000-007</b> Mini-WSB marking card; as card; not stretchable; plain; snap-on type	/000-007	248-501









	<b>Item no.: 248-501/000-012</b> Mini-WSB marking card; as card; not stretchable; plain; snap-on type	/000-012	248-501
	<b>Item no.: 248-501/000-017</b> Mini-WSB marking card; as card; not stretchable; plain; snap-on type	/000-017	248-501
	<b>Item no.: 248-501/000-023</b> Mini-WSB marking card; as card; not stretchable; plain; snap-on type	/000-023	248-501
	<b>Item no.: 248-501/000-024</b> Mini-WSB marking card; as card; not stretchable; plain; snap-on type	/000-024	248-501

#### Insulation stop

	<b>Item no.: 280-470</b> Insulation stop; 0.08 - 0.2 mm <sup>2</sup> "s" (0.14 mm <sup>2</sup> "f-st"); 5 pieces/strip		280-470
	<b>Item no.: 280-471</b> Insulation stop; 0.25 - 0.5 mm <sup>2</sup> ; 5 pieces/strip		280-471
	<b>Item no.: 280-472</b> Insulation stop; 0.75 - 1 mm <sup>2</sup> ; 5 pieces/strip		280-472

#### Jumper

	<b>Item no.: 280-482</b> Comb-style jumper bar; insulated; 2-way; IN = IN terminal block		280-482
	<b>Item no.: 280-483</b> Comb-style jumper bar; insulated; 3-way; IN = IN terminal block		280-483
	<b>Item no.: 280-484</b> Comb-style jumper bar; insulated; 4-way; IN = IN terminal block		280-484
	<b>Item no.: 280-485</b> Comb-style jumper bar; insulated; 5-way; IN = IN terminal block		280-485
	<b>Item no.: 280-490</b> Comb-style jumper bar; insulated; 10-way; IN = IN terminal block		280-490
	<b>Item no.: 280-492</b> Alternate comb-style jumper bar; insulated; 2-way; IN = IN terminal block		280-492

#### tools

	<b>Item no.: 210-720</b> Operating tool with partially insulated shaft; Type 2, blade (3.5 x 0.5) mm		210-720
--	---	--	---------

#### Downloads

#### Documentation

#### Additional Information



Disposal; Electrical and electronic equipment, Packaging

V 1.0.0

pdf  
265.8 kB

[Download](#)

---

### CAD/CAE - Smart Data

#### CAD data

3D Download 280-504/281-585

[URL](#)

[Download](#)

---

Subject to changes.

---